

Individual Remote Controller

Wired MA remote controller PAR-31MAA



Dimensions: 120(W) x 120(H) x 19(D) mm
: 4-3/4(W) x 4-3/4(H) x 3/4(D) in.

Example of system configuration

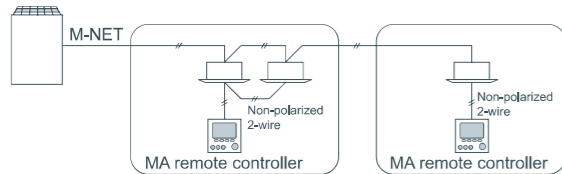

*When a PAR-31MAA is connected to a group, no other MA remote controllers can be connected to the same group.

Operation pattern during Auto (dual set point) mode

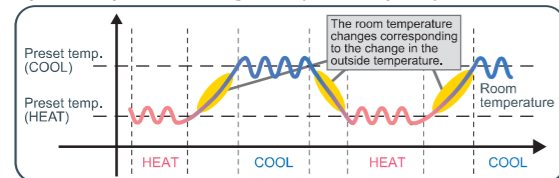

- Temperature will be displayed either in Centigrade in 0.5- or 1-degree increments, or in Fahrenheit, depending on the indoor unit model and the display mode setting on the remote controller.

Dual set point

When the operation mode is set to the Auto (dual set point) mode, two preset temperatures (one each for cooling and heating) can be set. Depending on the room temperature, indoor unit will automatically operate in either the Cool or Heat mode and keep the room temperature within the preset range.

*Please contact your Mitsubishi Electric sales office for details.

Backlit LCD (Liquid Crystal Display)

Large, easy-to-see display
Full-dot LCD display with large characters for easy viewing
Contrast also adjustable

Night Setback

To prevent indoor dew or excessive temperature rise, this control starts heating operation when the control object group is stopped and the room temperature drops below the preset lower limit temperature. Also, this control starts cooling operation when the control object group is stopped and the room temperature rises above the preset upper limit temperature.

Language selection

Language to be displayed on the screen can be selected from eight languages: English, French, German, Spanish, Italian, Portuguese, Swedish, and Russian.

Functions

Item	Description	Operations	Display
ON/OFF	Switches between ON and OFF.	○	○
Operation mode switching	Switches among Cool/Dry/Fan/Auto/Heat.	○	○
Room temp. setting	The temperature can be set within the following range. Cool/Drying : 19°C - 35°C/67°F - 95°F Heat : 4.5°C - 28°C/40°F - 83°F Auto (single set point) : 19°C - 28°C/67°F - 83°F Auto (dual set points) [Cool] Same as the set temp. range for Cool mode. [Heat] Same as the set temp. range for Heat mode. * Set temperature range varies depending on the model.	○	○
Air flow direction setting	Changes airflow direction. * Available airflow directions vary depending on the model.	○	○
Louver setting	Switches between louver ON/OFF.	○	○
Ventilation equipment control	Interlocked setting and interlocked operation setting with the CITY MULTI LOSSNAY units can be made. The Stop/Low/High settings of the ventilation equipment can be controlled.	○	○
Error information	When an error occurs, an error code and the unit address appear. Air conditioning unit model, serial number, and contact number can be set to appear when an error occurs. (The information above needs to be entered in advance.) * An error code may not appear depending on the error.	—	○
Timer	ON/OFF timer Turns ON and OFF daily at a set time. • Time can be set in 5-minute increments. • It is also possible to set the ON time only or the OFF time only. Auto-OFF timer Turns off the unit after a certain period of operation. • Operation time can be set to a value from 30 to 240 minutes in 10-minute increments.	○	○
Allows/disallows local operation	The following operation can be prohibited by making certain settings on the centralized controller: ON/OFF, operation mode setting, temperature setting, fan speed, air direction, and filter sign reset. * While an operation is prohibited, the operation icon lights up (only on the Main display in the "Full" mode).	×	○
Operation lock	The following operation can be prohibited respectively: ON/OFF, operation mode setting, temperature setting, and airflow direction setting.	○	○
Temperature range restriction	The room temperature range for each operation mode can be restricted.	○	○
Auto return	The units operate at the preset temperature after a designated period. (Time can be set to a value from 30 to 120 in 10-minute increments.) * Not valid when the temperature setting range is restricted.	○	×

Smart ME Controller PAR-U02MEDA



Dimensions : 140(W) x 120(H) x 25(D) mm
: 5-9/16(W) x 4-3/4(H) x 1(D) in.

- Smart ME Controller is a remote controller designed to control Mitsubishi Electric's air conditioning units and also allows for the control of other manufacturer's products connected via Mitsubishi Electric's AHC (Advanced HVAC CONTROLLER).

- It can control up to sixteen indoor units and one AHC.

- Smart ME Controller features such basic functions as operations and monitoring of air conditioning units and schedule-control functions and is equipped with four built-in sensors (temperature, humidity, occupancy, brightness), which enable an integrated control of the system, including the humidifiers and ventilation units connected to the system via AHC, to help create a comfortable environment.

When the built-in occupancy sensor detects vacancy in a specific zone, the controller uses its internal function to reduce energy-consumption.

Example of system configuration

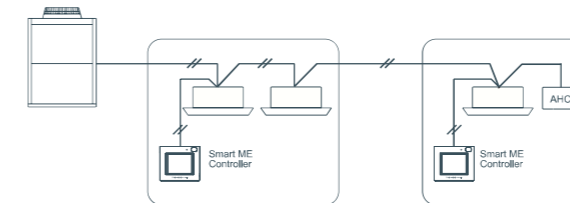

Functions

Item	Description	Operations	Display
ON/OFF	Switches between ON and OFF.	○	○
Operation mode switching	Switches between Cool / Drying / Fan / Heat / Auto. Operation modes vary depending on the indoor unit model. Auto mode is for CITY MULTI R2, and WR2 series only.	○	○
Temperature setting	The temperature can be set within the following range. Cool / Drying : 19°C - 35°C / 67°F - 95°F Heat : 4.5°C - 28°C / 40°F - 83°F Auto : (single set point) : 19°C - 28°C / 67°F - 83°F Auto : (dual set points) [Cool] Same as the set temp. range for Cool mode. [Heat] Same as the set temp. range for Heat mode. * The settable temperature ranges vary depending on the indoor unit model.	○	○
Fan speed setting	Changes fan speed. * Available fan speeds vary depending on the model.	○	○
Air flow direction setting	Changes airflow direction. * Available airflow directions vary depending on the model.	○	○
Allows/disallows local operation	The following operation can be prohibited by making certain settings on the centralized controller: ON/OFF, operation mode setting, temperature setting, fan speed, air direction, and filter sign reset. * While an operation is prohibited, the operation icon lights up.	×	○
Error information	When an error occurs, an error code and the unit address appear. Contact number can be set to appear when an error occurs. (The information above needs to be entered on the Service menu.)	—	○
Schedule (Weekly timer)	Weekly ON/OFF times, operation mode, and set temperatures can be set. • Time can be set in 5-minute increments. Up to 8 schedule patterns can be set per day of the week. * Not valid when the ON/OFF timer is set.	○	○
Timer	ON/OFF timer Turns ON and OFF daily at a set time. • Time can be set in 5-minute increments. • It is also possible to set the ON time only or the OFF time only. Auto-OFF timer Turns off the unit after a certain period of operation. • Operation time can be set to a value from 30 to 240 in 10-minute increments.	○	○
Energy-save control during vacancy	When vacancy is detected by the occupancy sensor, the energy-save control assist function is activated. Four control types are available for selection: ON/OFF/Set temperature/Fan speed/Thermo-off. The brightness sensor can be used in conjunction with the occupancy sensor to detect the occupancy/vacancy status more accurately.	○	○

Individual Remote Controller

Wireless remote controller PAR-FL32MA / PAR-FA32MA / PAR-SA9FA

Simple remote controller PAC-YT52CRA (MA)



Dimensions: 70(W) x 120(H) x 14.5(D) mm
: 2-3/4(W) x 4-23/32(H) x 9/16(D) in.

Example of system configuration

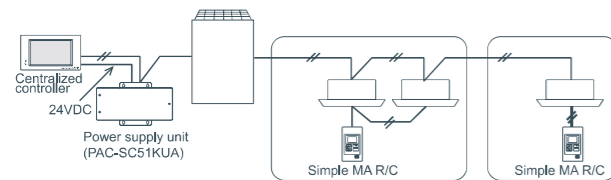

- Dual set point**
 When the operation mode is set to the Auto (dual set point) mode, two preset temperatures (one each for cooling and heating) can be set. Depending on the room temperature, indoor unit will automatically operate in either the Cool or Heat mode and keep the room temperature within the preset range.
 *Please contact your Mitsubishi Electric sales office for details.
- Backlit LCD**
 Backlight for operation in dark place
- Flat back**
 Install without hole on wall Slim and flat type Thickness is less than 14.5mm [0.6(in)]
- Vane button (standard)**
 The Vane button has been added to allow the user to change airflow direction (ceiling-cassette and wall-mounted types).

Pressing the button will switch the vane directions.



- *The settable vane direction varies depending on the indoor unit model to be connected.
- * If the unit has no vane function, the vane direction cannot be set. In this case, the vane icon blinks when the button is pressed.

- The only wiring required is cross-over wiring based on two-wire signal lines.**
- Room temperature sensors are built-in.**
- Can operate all types of indoor units**
 *Since this controller has limited functions, it should always be used in conjunction with standard controller or centralized controller.
- LCD temperature setting and display in 1°C /1°F increments.**

Functions

Item	Description	Operations	Display
ON/OFF	Changes between ON and OFF.	○	○
Operation mode switching	Select from COOL, DRYING, FAN, AUTO, and HEAT. * AUTO mode is settable only when those functions are available on the indoor unit.	○	○
Temperature setting	The temperature can be set within the following range. Cool/Dry : 19°C - 35°C/67°F - 95°F Heat : 4.5°C - 28°C/40°F - 83°F Auto (single set point) : 19°C - 28°C/67°F - 83°F Auto (dual set points) [Cool] Same as the set temp. range for Cool mode. [Heat] Same as the set temp. range for Heat mode. * Set temperature range varies depending on the model.	○	○
Fan speed setting	Changes the fan speed. * The settable fan speed varies depending on the indoor unit model to be connected.	○	○
Permit / Prohibit local operation	By setting a centralized controller, the following local operations are prohibited: ON/OFF; operation mode; preset temperature; * The CENTRAL icon appears while the local operations are prohibited.	×	○
Error	Displays the current error status with the address. * The address may not be displayed depending on the error status.	×	□
Ventilation equipment	When the CITY MULTI indoor unit is connected, interlocked setting of the CITY MULTI LOSSNAY unit is possible. When the Mr. SLIM indoor unit (A-control) is connected, interlocked operation of the microcomputer-type LOSSNAY unit is possible.	○	○
Set temperature range limit	The preset temperature range can be restricted for each operation mode (COOL/HEAT/AUTO).	○	○

Remote Controller



PAR-FL32MA

Dimensions: 58(W) x 159(H) x 19(D) mm
: 2-5/16(W) x 6-5/16(H) x 3/4(D) in.



PAR-FA32MA

Dimensions: 70(W) x 120(H) x 22.5(D) mm
: 2-3/4(W) x 4-3/4(H) x 7/8(D) in.



PAR-SA9FA-E
(4-way Cassette signal receiver)

Dimensions: 256(H) x 19(D) mm



PAR-SL94B-E

(Wireless remote controller kit for ceiling suspended)

Dimensions: 182(W) x 57(H) x 31(D) mm

- No need to configure addresses for group operation.**
- Lit LED keeps you informed of operation - blinking even gives you the error code via the number of blinks.**
- Can be used with the MA remote controller.**
 *When used in group configurations, wiring between indoor units is required.
 *Combining ME remote controller and/or LOSSNAY remote controller in a group is not possible.
- LCD temperature setting and display in 1°C /1°F increments.**

Example of system configuration

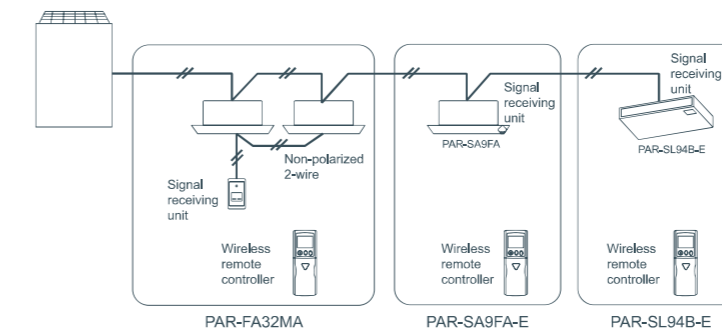

Correspondence table

	receiver	transmitter
PMFY-P VBM		
PLFY-P VCM/VLMD		
PFFY-P VKM		
PEFY-P VMR-E-L/R/VMH	PAR-FA32MA	
PFFY-P VLEM/VKM/VLRM/VLRMM		PAR-FL32MA
PEFY-P VMS1(L)		
PEFY-VMA(L)		
PCFY-P VKM	PAR-FA32MA	
PLFY-P VBM-E	PAR-SL94B-E	
PKFY-P VBM-E	PAR-SA9FA-E	
PKFY-P VHM/VKM	Built-in	

Functions

Item	Description	Operations	Display
ON/OFF	ON and OFF operation for a single group	○	○
Temperature setting	Sets the temperature for a single group Range of temperature setting Cool/Dry : 19°C - 30°C (14°C - 30°C) / 67°F - 87°F (57°F - 87°F) Heat : 17°C - 28°C (17°C - 28°C) / 63°F - 83°F (63°F - 83°F) Auto : 19°C - 28°C (17°C - 28°C) / 67°F - 83°F (63°F - 83°F) () For PEFY/PFFY by setting DipSW 7-1 to ON and limits to N16H fan speed only. * Set to PAR-FL32MA according to its Installation Manual 4 "Model setting".	○	○
Air flow direction setting	Air flow direction angles (4-angle, Swing) Auto Louver ON/OFF. Air flow direction settings vary depending on the model.	*	*
Timer operation	One ON/OFF setting can be set for one day.	○	○
Permit / Prohibit local operation	Individually prohibit operation of each local remote control function (ON/OFF, Change operation mode, Set temperature, Reset filter). *1 If operation is performed when the local remote controller inactivation command is received from the main system controller, a buzzer will ring and an LED will flash.	×	○ ^{*1}
Ventilation equipment	Up to 16 indoor units can be connected to an interlocked system that has one LOSSNAY. The LOSSNAY will run in interlock with the operation of indoor unit. *2 The fan rate and mode cannot be changed.	×	×

* Some models will have different display for the air flow direction and fan speed. Set the air flow direction and fan speed when performing initial setting.

Remote Controller

Centralized Remote Controller

With our new Advanced Touch Controller AT-50B, easy and simple operation on the touch panel offers an optimal air environment for individual unit.

Advanced Touch controller AT-50B

NEW



Dimensions: 180(W) x 120(H) x 30(D) mm
: 7-2/16(W) x 4-12/16(H) x 1-3/16(D) in.

- Temperature will be displayed either in Centigrade in 0.5- or 1-degree increments, or in Fahrenheit, depending on the indoor unit model and the display mode setting on the remote controller.

- **Dual set point**
When the operation mode is set to the Auto (dual set point) mode, two preset temperatures (one each for cooling and heating) can be set. Depending on the room temperature, indoor unit will automatically operate in either the Cool or Heat mode and keep the room temperature within the preset range.

*Please contact your Mitsubishi Electric sales office for details.

System structure

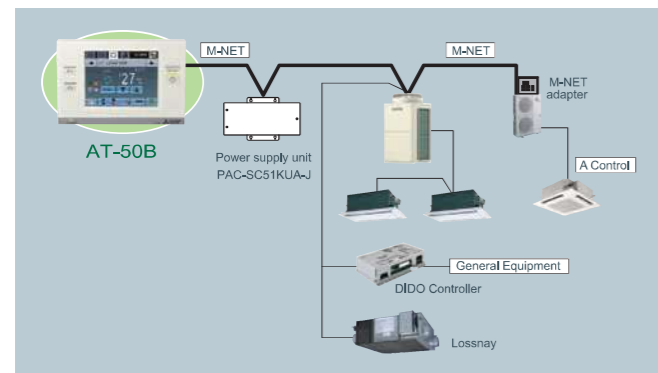

Operation pattern during Auto (dual set point) mode

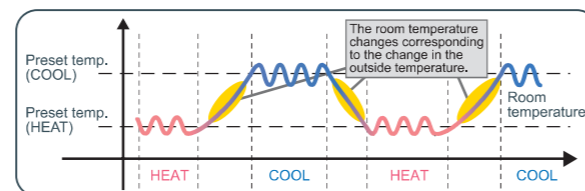

Functions

Three in One

The following three features are integrated into AT-50B.

- Control up to 50 indoor units from one location
- A weekly programmable timer, being able to control up to 50 indoor units
- Control up to 50 units/50 groups of air conditioners

Weekly and daily schedule

5 patterns of one day and 12 patterns of weekly schedule (16 settings max. per pattern).

Two types of weekly schedule can be set.

System changeover

Operation mode can be switched depending on indoor temperature setting and target temperature of each group or a representative indoor unit.

Night setback function

This function allows having a two-temperature setting to keep the desired room temperature when the units are not in operation and during the time this function is effective. The unit automatically starts heating (cooling) operation when the temperature drops below (rises above) the preset lower (upper) limit temperature. This is not only for comfort environment, but also for saving energy.

Main system controller/Sub system controller

AT-50B can be set to Sub System controller. When connecting multiple system controllers, designate the system controller with many functions as the "Main", and set the system controllers with few functions as the "Sub".

Simple button arrangement

The F1 (Function 1) and the F2 (Function 2) button can be set as a run button of the following collective operation. (Setback/Schedule/Operation Mode/Temperature Correction/Remote Controller Prohibition)

Functions

[Basic Functions]

- ON/OFF
- Operation mode switching
- Temperature setting
- Fan speed setting
- Airflow direction setting
- Louver setting

Advanced Functions

Item	Description	Operations	Display
Permit / Prohibit	The ON/OFF, operation mode, setting temperature, fan speed, air direction, filter sign reset operations, and timer using the local remote controllers can be prohibited. Only ON/OFF and filter reset can be prohibited for the LOSSNAY group. *The settable items vary depending on the models.	○	○
Operation lock	The operation lock can be set to the input operation of AT-50B. Each button can be set. (Function Button 1, Function Button 2, Collective ON/OFF, Touch Panel) The password for the lock release can be set.	○	○
Error display	When an error is currently occurring on an air conditioner unit, the afflicted unit and the error code are displayed. * When an error occurs, the "ON/OFF" LED flashes. The operation monitor screen show abnormal icon over the unit. The error monitor screen shows the abnormal unit address and error code. The error log monitor screen shows the time and date, the abnormal unit address, error code and source of detection.	×	□○
Ventilation (independent)	Switches the mode "Bypass/Heat recovery/Auto" for LOSSNAY groups.	○	○
Ventilation (interlocked)	The LOSSNAY will run in interlock with the operation of indoor unit. The mode cannot be changed. The LED will turn ON during operation after interlocking.	○	○
Temperature-set limitation	Batch-setting to temperature range limit at cooling, heating, and auto mode. This function cannot be used with the MA remote controller. (Depends on the indoor unit model.)	○	○
Specific mode operation prohibit (Cooling prohibit, heating prohibit, cooling/heating prohibit)	When set as the main controller, operation of the following modes with the local remote controllers can be prohibited. When cooling is prohibited: Cooling, dry, automatic can not be chosen. When heating is prohibited: Heating, automatic can not be chosen. When cooling/heating is prohibited: Cooling, dry, heating, automatic can not be chosen.	○	○
External input (Emergency stop input, etc.)	The following input with level signals or pulse signals are available. Level signal: "Emergency stop input" or "Collective ON/OFF" Pulse signal: "Collective ON/OFF" or "Local remote controller prohibit/permit" One input can be selected from those above. * An external input/output adapter (PAC-YT41HAA (sold separately)) is required. Relays and DC power supply or other devices must be prepared at the site.	○	○
External output (Error output, operation output)	"ON/OFF" and "error/normal" are output with the level signal. * An external input/output adapter (PAC-YT41HAA, PAC-YT51HAA (sold separately)) is required. Relays and DC power supply or other devices must be prepared at the site.	○	○
Checking the Gas Amount	Use this function to check for refrigerant leak from the outdoor unit. * When this function is used, the gas amount checking function of the outdoor unit cannot be used. This function is for CITY MULTI R2 and Y (PUMY is excluded.) series only.	□	□
Schedule operation	Weekly schedule setting up to 12 pattern is available. In one pattern, up to 16 setting of "ON/OFF", "Operation mode", "Set Temperature", "Fan speed", "Air flow direction" and "Permit / Prohibit local operation" can be scheduled. Two types of weekly schedule(Summer/Winter) can be set. Today's schedule setting up to 5 pattern in available.	○	○

* Depending on the installation conditions, power supply unit (PAC-SC51KUA) is required. Please contact your local distributor or MITSUBISHI ELECTRIC branch office for further information.

Design

Backlit LCD (Liquid Crystal Display) Touch Panel

5-inch color LCD touch panel enables easy and simple operation.

The backlight lights up when the panel is touched, and lights off after certain period of time.

The touch panel displays the operation status of the units in GRID, LIST or in GROUP.



GRID (zoom-out) screen
Displays the operation status of all groups.



GRID (zoom-in) screen
Displays the detailed operation status of each group.



LIST screen
Displays the detailed operation status of each group with group name.



GROUP screen
Displays the detailed operation status of each group. Sets group operations.

Centralized Remote Controller

With a new colored touch panel, and continuation of all the G-50A functions, AG-150A visualizes its functions from basic control to advanced operations and bringing an ultimate controller to reality.

Centralized controller AG-150A



Dimensions: 300(W) x 185(H) x 70.3(D) mm
: 11-13/16(W) x 7-5/16(H) x 2-13/16(D) in.



Option : Black surface cover
PAC-YG71CBL

System structure

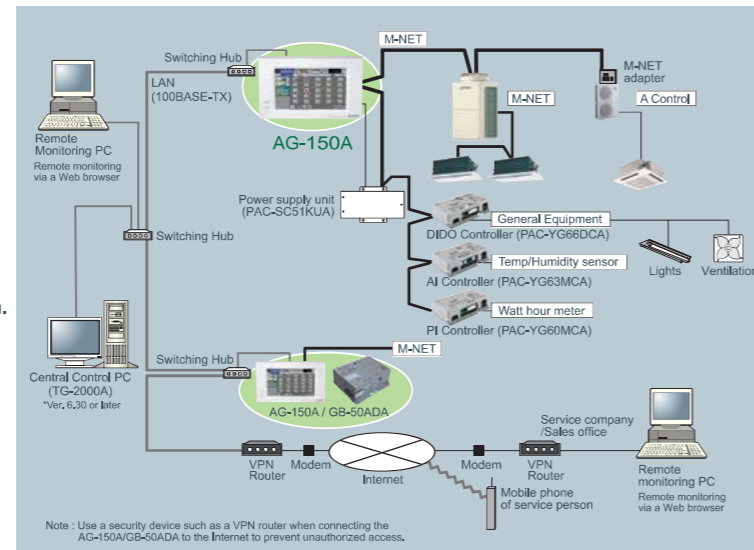

Note : Use a security device such as a VPN router when connecting the AG-150A/GB-50ADA to the Internet to prevent unauthorized access.

Expansion Controller PAC-YG50ECA



Dimensions: 250(W) x 217(H) x 97.2(D) mm
: 9-7/8(W) x 8-9/16(H) x 3-7/8(D) in.

With a connection of a Expansion Controller, maximum of 150 units/groups can be connected to AG-150A.

System structure

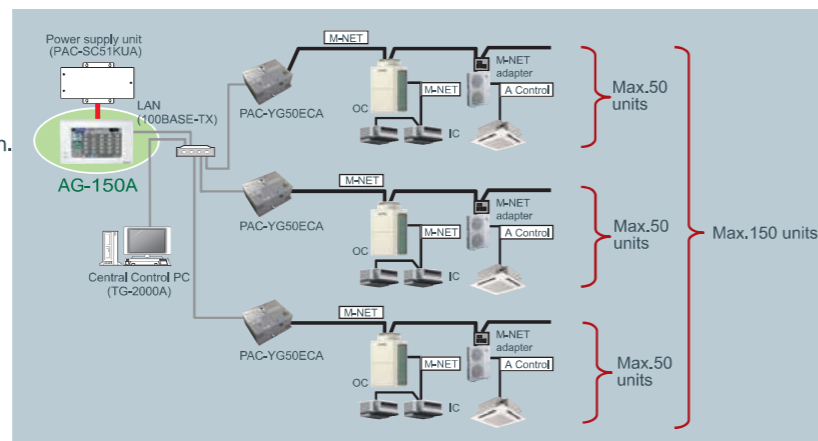

*Do not connect PAC-YG50ECA to TB3 of the outdoor unit.

*Use a security device such as a VPN router when connecting the AG-150A etc. to the Internet to prevent unauthorized access.

Design

Backlight color liquid crystal

Backlight makes it easy to see and control units.
One can identify whether a unit is ON or OFF from a distance.
Control in the night with no lights is possible.

Touch panel

9 inch wide, high-resolution
Touch panel enables operation of units by touching with index finger.
When object unit is touched, orange box appears around the unit icon indicating the unit selected.

Flat back

Easy installation
Allows for an installation of the unit either directly to the wall surface* or using the installation hole in the wall.
*Optional parts are required.

USB memory compatible

Measurement/initial setting CSV data extractable with USB memory.
Can save and overwrite setting data.

Functions

Controllable units/groups

Controls up to 50 units/groups (including indoor units, LOSSNAY, DIDO/AI/PI controller)
Up to 150 units can be controlled via expansion controller; PAC-YG50ECA (AG-150A software needs to be upgraded to Ver. 2.10 or later.)

Monitoring functions

Temperature/Humidity (using AI controller)
General equipment such as lights on LCD (using DIDO controller)
Interlock function from AI controller, DIDO controller to indoor units and between DIDO units are available.
AG-150A interlock with DIDO controller or free contact on an indoor unit available. * Ver. 2.30 or later

Energy saving functions

Seasonal scheduling and automatic switch over *1
Yearly scheduling on LCD *1
Scheduling fan speed and airflow direction
Optimized Start up
External temperature interlock control
Night setback control
*1 License required.

Functions

Item	Description	Operations	Display
Controllable unit	50 units/groups or 150 units/groups via expansion controller; PAC-YG50ECA.		
ON/OFF	Run and stop operation for the air conditioner units and general equipment. (To operate general equipment, PAC-YG66DCA is required.)	○ ○ △ ●	○ ○
Mode selection	Switches between Cool / Dry / Auto / Fan / Heat. (Group of LOSSNAY unit : automatic ventilation/ vent - heat interchange/ normal ventilation) depending on the air conditioner unit. Auto mode is for CITY MULTI R2 and WR2 series only.	○ ○ △ ●	○
Temperature setting	Cool/Dry : 19°C-30°C (14°C-30°C) / 67°F-87°F (57°F-87°F) Heat : 17°C-28°C (17°C-28°C) / 63°F-83°F (63°F-83°F) Auto : 19°C-28°C (17°C-28°C) / 63°F-83°F (63°F-83°F) () in case of using middle-temperature on PEFY-VML/VMR/VMS/VMH by setting DipSW7-1 to ON. Yet, PEFY-P-VMH-E-F is excluded.	○ ○ △ ●	○
Fan speed setting	Models with 4 air flow speed settings: Hi/Mid-2/Mid-1/Low Models with 3 air flow speed settings: Hi/Mid/Low Models with 2 air flow speed settings: Hi/Low Fan speed setting (including Auto) varies depending on the model.	○ ○ △ ●	○
Air flow direction setting	Air flow direction angles, 4-angle or 5-angle Swing, Auto (Louver cannot be set)	○ ○ △ ●	○
Schedule operation	Annual/Weekly (5 types)/today schedule can be set for each group of air conditioning units. Optimized startup setting is also available.	○ ○ △ ●	○
Permit / Prohibit local operation	Individually prohibit operation of each local remote control function (Start/Stop, Change operation mode, Set temperature, Reset filter).	○ ○ △ ●	○
Indoor unit intake temperature	Measures the intake temperature of the indoor unit only when the indoor unit is operating.	×	○
Error	When an error is currently occurring on an air conditioner unit, the afflicted unit and the error code are displayed.	×	□ ○
Test run	This operates air conditioner units in test run mode.	○ ○ △ ●	○
Ventilation interlock	The ventilation unit (LOSSNAY) is able to automatically start its operation when operation of the interlocked indoor unit starts.	○ ○ △ ●	○
External input/output	By using optional external input/output adaptor (PAC-YG10HA) you can set and monitor the following. Input : By level signal : "Batch start/stop", "Batch emergency stop" By pulse signal : "Batch start/stop", "Enable/disable local remote controller" Output : "Start/stop", "Error/Normal"	○	○

*NOTE: Operation and displayed content vary depending on the indoor unit model.
◆Future release schedule is subject to change without notice.

Centralized Remote Controller

Just press a switch to start. All of the units can be On/Off by pressing the main switch, and each unit in the group can be On/Off with individual switch. The PAC-YT40ANRA also has hardwired connection available (On/Off input, fire alarm input, run output, fault output).

ON/OFF remote controller PAC-YT40ANRA

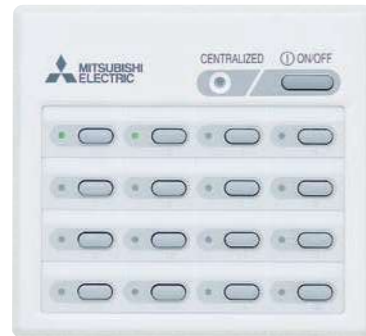

Dimensions: 130(W) x 120(H) x 19(D) mm
: 5-1/8(W) x 4-23/32(H) x 3/4(D) in.

- The group setting is kept in nonvolatile memory. No need to worry about re-setting at power failure.
- No individual AC power supply is needed. The power can be supplied from one outdoor unit (R410A) or Power supply unit.

System example

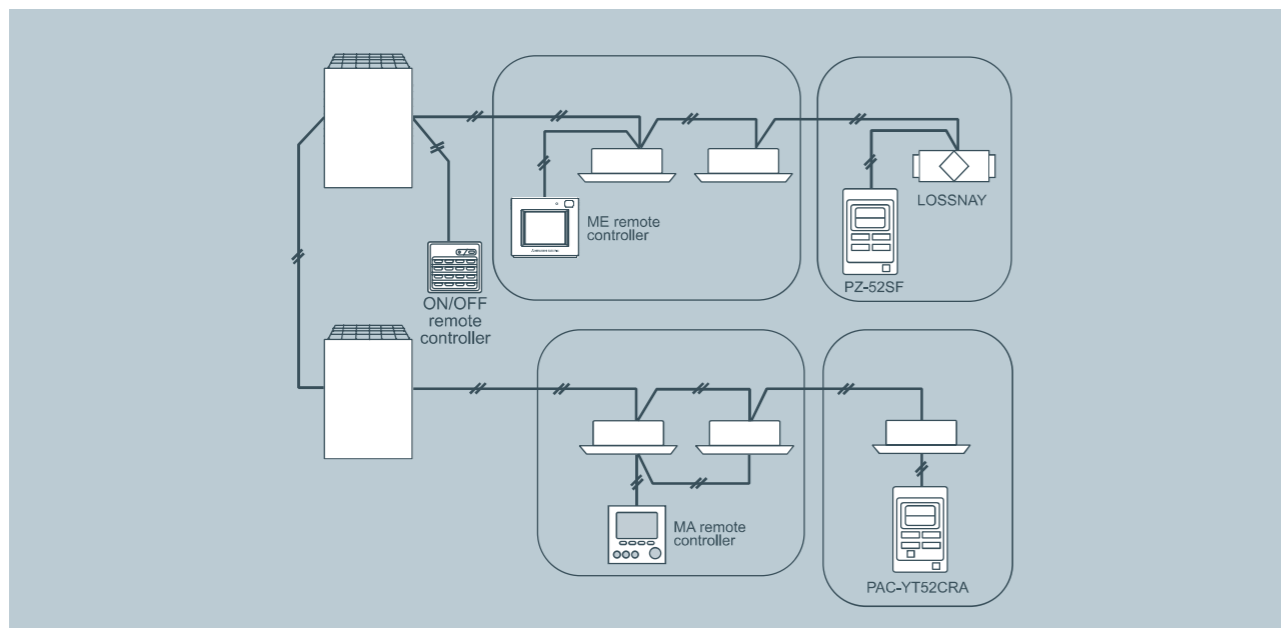

FUNCTION	DESCRIPTION	PAC-YT40ANRA	
		OPERATIONS	DISPLAY
UNITS	Max No.Units	50 units/16 groups	
ON/OFF	Run and stop operation	✓	✓
ERROR INDICATION	LED flashes during failure. (The error code can be confirmed by removing the cover.)	—	✓
VENTILATION OPERATION (INDEPENDENT)	Group operation of only LOSSNAY units possible. *Only ON/OFF of group.	✓	✓
VENTILATION OPERATION (INTERLOCKED)	The LOSSNAY will run in interlock with the operation of indoor unit. *The fan rate and mode cannot be changed. The LED will turn ON only during operation after interlocking.	✓	✓
EXTERNAL INPUT	On/Off/Fire Alarm *	✓	—
EXTERNAL OUTPUT	On/Off/Faults *	—	✓

* Applicable to collective only
Not applicable to groups

Centralized controller EB-50GU-J



EB-50GU-J (without display)
• Dimensions:9-7/8 (W) x 8-9/16 (H) x 3-7/8 (D) in.
:250 (W) x 217 (H) x 97.2 (D) mm



Java is a registered trademark of Oracle and/or its affiliates.

The Web Server Function enables Remote Operation or Scheduling Via a Web Browser on a Personal Computer!
Up to 50 indoor units can be controlled!

Web Browser

Enables monitoring and operation of indoor units using a PC with Microsoft® Internet Explorer (Ver.8 or Ver.9)

*When connecting to the Internet, please use the VPN (Virtual Private Network).

Using "Dial-up Connection"

- Enables monitoring and operation from a remote place
- Enables error notification by e-mails to a PC or to a mobile phone

□:Each unit ○:Each group ●:Each block △:Each floor ⊙:Collective X:Not available

Function	Description	Operations	Display
ON / OFF	Run and stop operation for the air conditioner units	○●⊙	○●
Mode selection	Switches between COOL/DRY/FAN/AUTO/HEAT	○●⊙	○
Temperature setting	The room temperature can be set for all floors or in block, floor or group units. Set temperature range COOL / DRY :19°C to 30°C / 66°F to 86°F HEAT :17°C to 28°C / 63°F to 82°F AUTO (single set point) :19°C to 28°C / 66°F to 82°F *Depend on the model AUTO (dual set points) [Cool] Same as the set temp. range for Cool mode. [Heat] Same as the set temp. range for Heat mode.	○●⊙	○
Air flow direction setting	Air flow direction angles, 4-angle or 5-angle Swing, Auto (Louver cannot be set)	○●⊙	○
Timer operation / Schedule	Annual/Weekly (5 types)/today schedule can be set for each group of air conditioning units. Optimized startup setting is also available.	○●⊙	○
Permit / Prohibit function	Individually prohibit operation of each local remote control function	○●⊙	○
Indoor unit intake temperature	Measures the intake temperature of the indoor unit only when the indoor unit is operating.	X	○
Error	When an error is currently occurring on an air conditioner unit, the afflicted unit and the error code are displayed.	X	□
Test run	This operates air conditioner units in test run mode.	○●⊙	○
Ventilation interlock	Operation of indoor groups or general equipment can be interlocked by the change of state (ON/OFF, mode, error of indoor groups and general equipment).	○	○
AHC status	Displays the status of input and output ports of each Advanced HVAC CONTROLLER (AHC).	X	□
Energy Use Status	On the Energy Use Status screen, the energy-control-related status, such as electric energy consumption, operation time, and outdoor temperature, can be displayed in a graph. Operators can check the detailed status of given indoor units by specifying the date to display the data per group, block, or unit address.	X	□○●

*NOTE: Operation and displayed content vary depending on the indoor unit model.

System Structure (image)

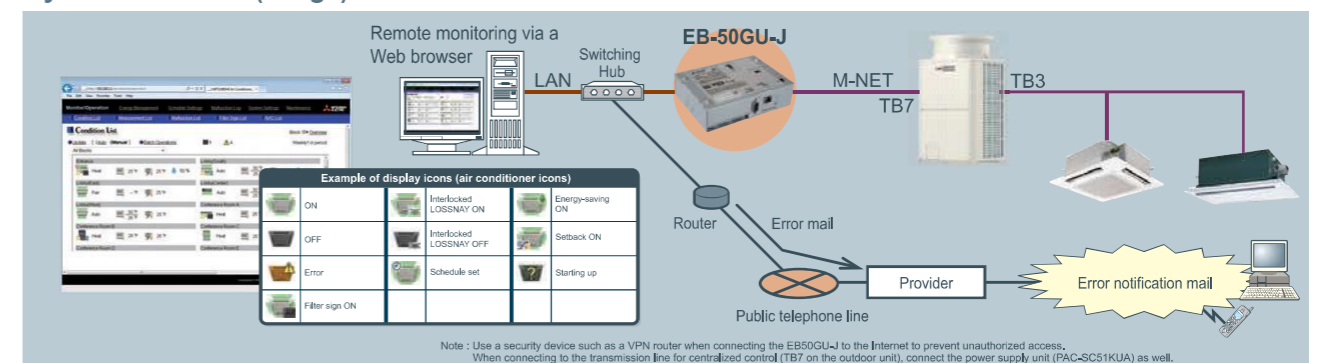

Annual / Weekly Schedule

Enables Weekly and Annual scheduling with a registering license

- The operations that can be scheduled for air conditioning unit group: ON/OFF/Optimized Start, Mode, Set Temp, Air Direction, Fan Speed, and Prohibit Remote Controller operation
- For annual schedule, it is possible to set 50 day-long settings up to 24 months into the future.

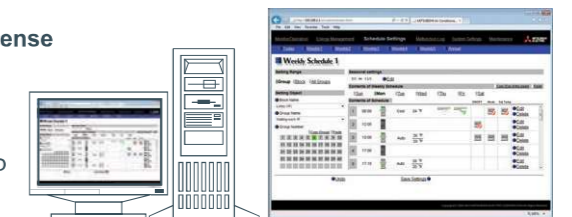

Scheduling example in the office

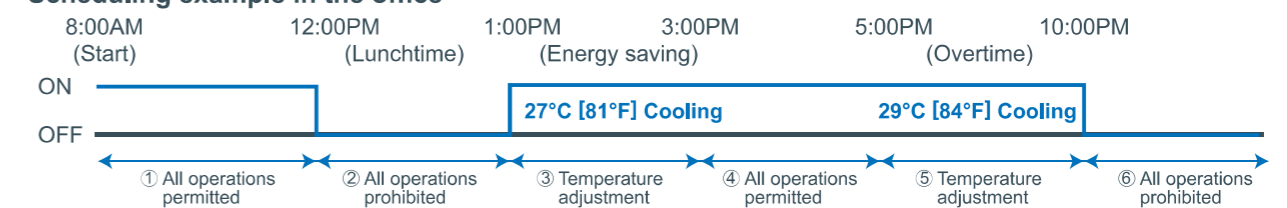

Up to 24 operation settings per day in 1-minute increment

Centralized controller GB-50ADA-J*

*GB-50ADA-J is indicated as GB-50ADA.



GB-50ADA-J (without display)

• Dimensions: 250 (W) x 217 (H) x 97.2 (D) mm
: 9-7/8 (W) x 8-9/16 (H) x 3-7/8 (D) in.

The Web Server Function enables Remote Operation or Scheduling Via a Web Browser on a Personal Computer!
Up to 50 indoor units can be controlled!

Web Browser

Enables monitoring and operation of indoor units using a PC with Microsoft® Internet Explorer (Ver.6 or 7 or 8) (Web browser function is an optional and needs license registration.)

*When connecting to the Internet, please use the VPN (Virtual Private Network).

Using "Dial-up Connection"

- Enables monitoring and operation from a remote place
- Enables error notification by e-mails to a PC or to a mobile phone

Function	Description
	GB-50ADA-J (web browser)
ON / OFF	Run and stop operation for the air conditioner units
Mode selection	Switches between Cool / Dry / Auto / Fan / Heat.
Temperature setting	The temperature can be set within the following range. Cool/Dry : 19°C-30°C (14°C-30°C) / 67°F-87°F (57°F-87°F) Heat : 17°C-28°C (17°C-28°C) / 63°F-83°F (63°F-83°F) Auto : 19°C-28°C (17°C-28°C) / 67°F-83°F (63°F-83°F) () in case of using middle-temperature on PEFY, PEFY-VML/VMR/VMS/VMH by setting DipSW7-1 to ON. Yet, PEFY-P-VMHE-F is excluded. *Set temperature range varies depending on the model.
Air flow direction setting	Air flow direction angles, 4-angle or 5-angle Swing, Auto (Louver cannot be set)
Schedule operation	Annau/Weekly (5 types)/today schedule can be set for each group of air conditioning units. Optimized startup setting is also available.
Permit / Prohibit function	Individually prohibit operation of each local remote control function
Indoor unit intake temperature	Measures the intake temperature of the indoor unit only when the indoor unit is operating.
Error	When an error is currently occurring on an air conditioner unit, the afflicted unit and the error code are displayed.
Test run	-
Ventilation interlock	Operation of indoor groups or general equipment can be interlocked by the change of state (ON/OFF, mode, error of indoor groups and general equipment).

*NOTE: Operation and displayed content vary depending on the indoor unit model.
License registration is necessary to perform each function on GB-50ADA-J.

System Structure

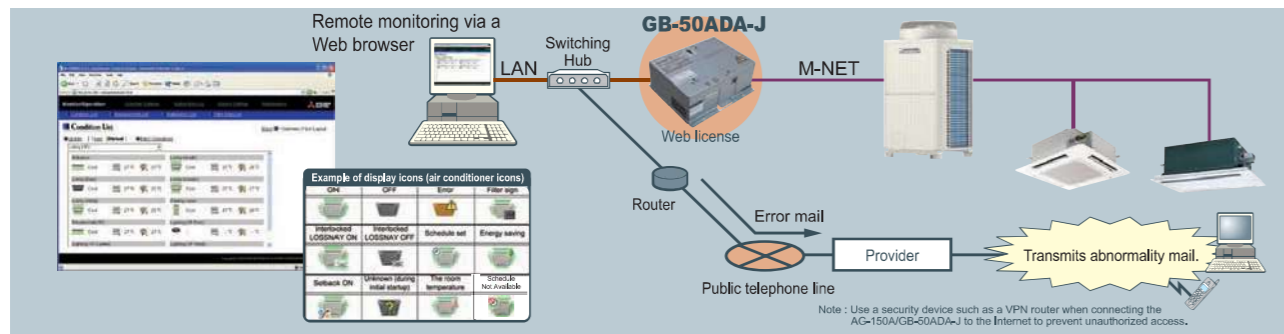

Annual / Weekly Schedule

Enables Weekly and Annual scheduling with a registering license

- The operations that can be scheduled for air conditioning unit group: ON/OFF/Optimized Start, Mode, Set Temp, Air Direction, Fan Speed, and Prohibit Remote Controller operation
- For annual schedule, it is possible to set 50 day-long settings up to 24 months into the future.



Scheduling example in the office

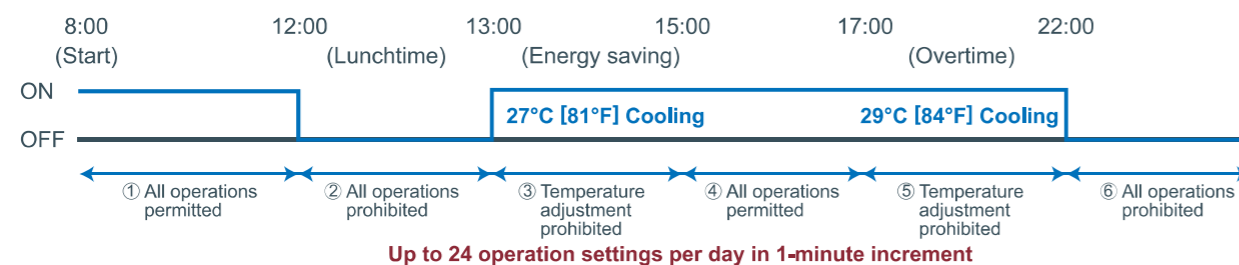

AHC ADAPTER PAC-IF01AHC-J



Dimensions: 116(W) x 90(H) x 40(D) mm
: 4-9/16(W) x 3-1/2(H) x 1-9/16(D) in.

Advanced HVAC CONTROLLER (hereafter referred to as AHC) comprises of MITSUBISHI ELECTRIC's AHC ADAPTER (PAC-IF01AHC-J) and α2 SIMPLE APPLICATION CONTROLLER* (hereafter referred to as ALPHA2).

*α2 SIMPLE APPLICATION CONTROLLER is one of the Programming Logic Controllers that are manufactured by MITSUBISHI ELECTRIC CORPORATION.

AHC allows for the connection of MITSUBISHI ELECTRIC's air conditioning network system (hereafter referred to as M-NET) to other systems, which was not possible with the use of ALPHA2 alone. AHC provides the following functions.

- ① Controls external devices using the sensor data of the air conditioning units connected to M-NET.
- ② Interlocks the operation of air conditioning units and external devices that are connected to ALPHA2.
- ③ Controls air conditioning units that are connected to M-NET.
- ④ Allows for the combined use of the items ①-③ above.
- ⑤ Monitors the input/output status of ALPHA2 via a remote controller or a centralized controller.

Compatible controllers

- Remote Controller: PAR-U02MEDA
- Centralized Controller: EB-50GU-J

- * Refer to the manual that came with ALPHA2 for information about ALPHA2.
- * The use of AHC ADAPTER requires either a remote controller or a centralized controller.

System Structure

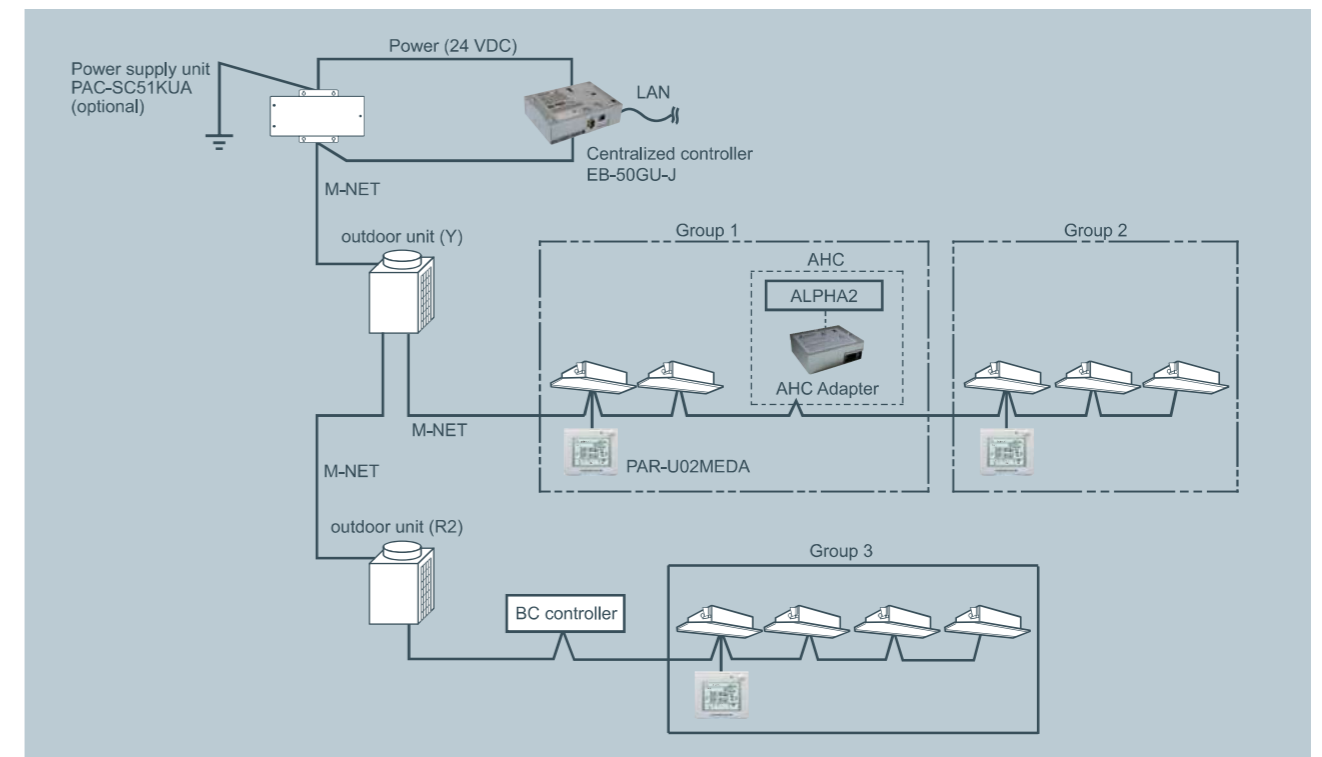

Centralized Remote Controller

PI Controller PAC-YG60MCA



Dimension: 200(W) x 120(H) x 45(D) mm
: 7-7/8(W) x 4-3/4(H) x 1-13/16(D) in.

No more PLCs are needed!
Our new PI controller makes it possible to perform energy saving without PLC, which is cost saving. Maximum of 4 measurement meter (WHM, gas meter, water meter, calorie meter) can be connected to the PI controller and can be used also for charge calculation.
*24 VDC power needs to be provided on site.

Energy Saving Control (Peak Cut)

Enables Energy Saving Control with the use of our new PI controller. (Registration of "Energy Management license pack" is required.)

To perform energy saving, the capacity of the outdoor unit is controlled.

*Please note that when using an energy saving control, there are no warranties to failures such as usage over the contracted electricity.

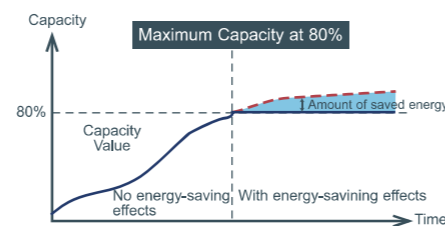

System Structure

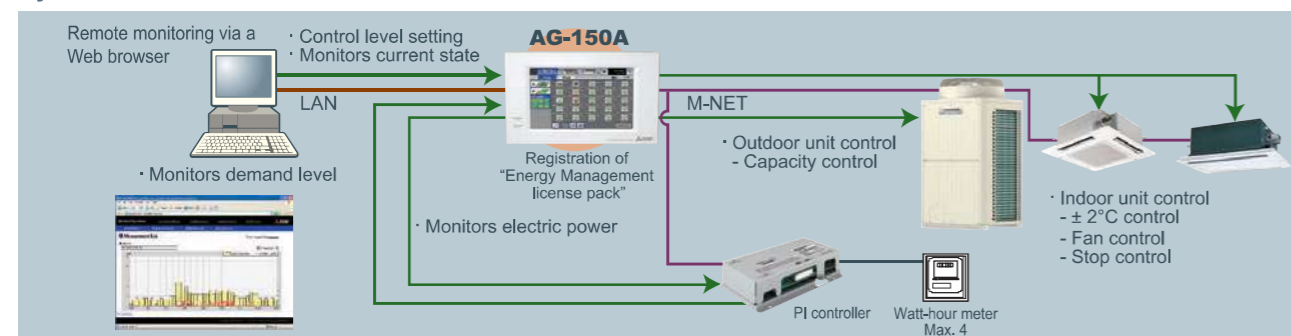

Charge Calculation

Enables charge calculation for each tenant and output as CSV file

System Structure

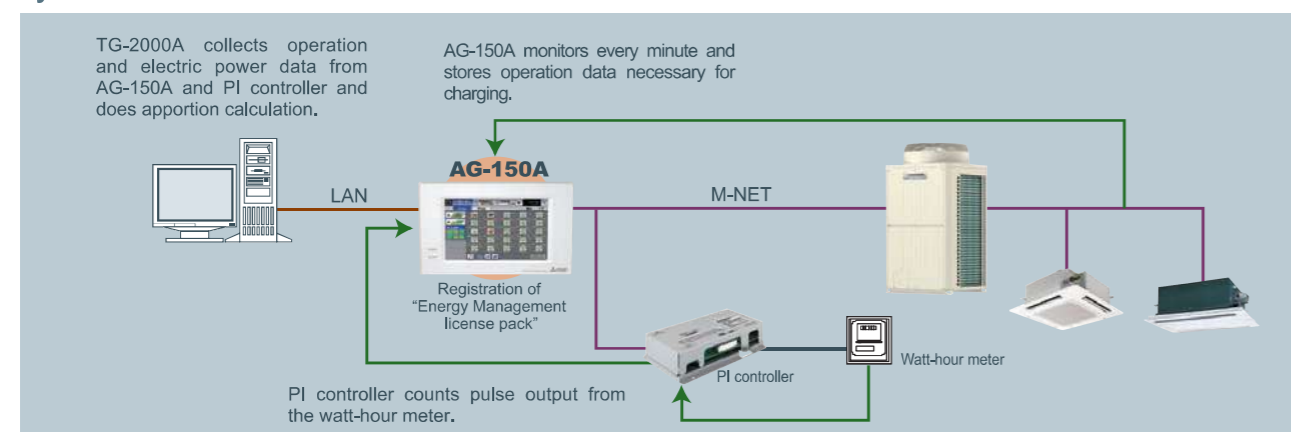

DIDO Controller PAC-YG66DCA



Dimension: 200(W) x 120(H) x 45(D) mm
: 7-7/8(W) x 4-3/4(H) x 1-13/16(D) in.

No more PLCs are needed!
Our new DIDO controller makes it possible to control general-purpose equipment without PLC, which is cost saving. Up to 6 general-purpose equipment can be connected to the DIDO controller.
*24 VDC power needs to be provided on site.

General-purpose equipment Control

Enables to control and monitor equipment other than air-conditioners (air-conditioners of other companies, lights, ventilators, etc.)

System Structure

- In addition to above, the air-conditioners can be interlocked with general-purpose equipment. E.g. Interlock between indoor units and security system.
- The indoor units can be turned ON/OFF when the security system is activated/deactivated.

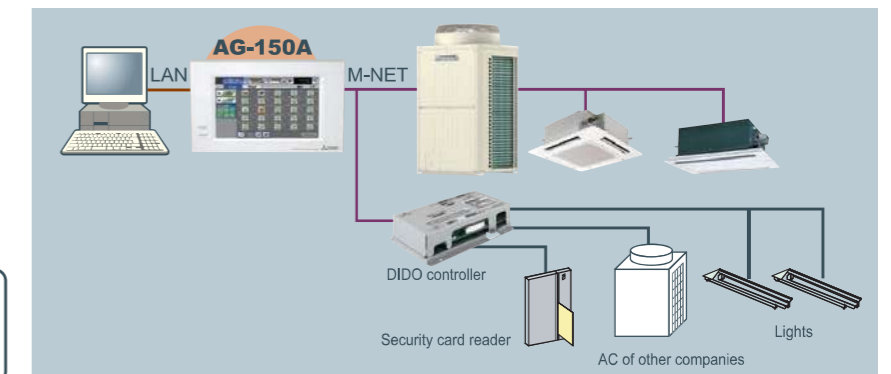
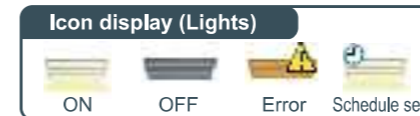

AI Controller PAC-YG63MCA



Dimension: 200(W) x 120(H) x 45(D) mm
: 7-7/8(W) x 4-3/4(H) x 1-13/16(D) in.

Our new AI controller makes it possible to monitor the values measured by the temperature/humidity sensor connected to the AI controller.
The AI controller has two input and two output channels.
*24 VDC power needs to be provided on site.

Temperature/Humidity Monitoring

Monitors the values measured by the temperature/humidity sensor connected to the AI controller

Temperature : Pt100, 4 to 20mA DC, 1 to 5 VDC, 0 to 10 VDC
Humidity : 4 to 20mA DC, 1 to 5 VDC, 0 to 10 VDC

- Trend displays of measurement data can be shown on a Web browser.
- An alarm can be output by e-mail when measurement data exceeds a preset upper or lower limit.

System Structure

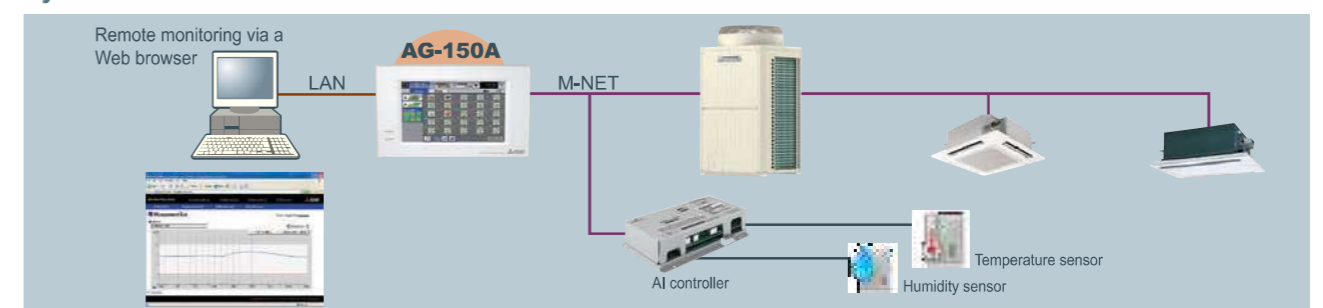

Centralized Remote Controller

Integrated centralized control software TG-2000A

Example of Basic System Configuration

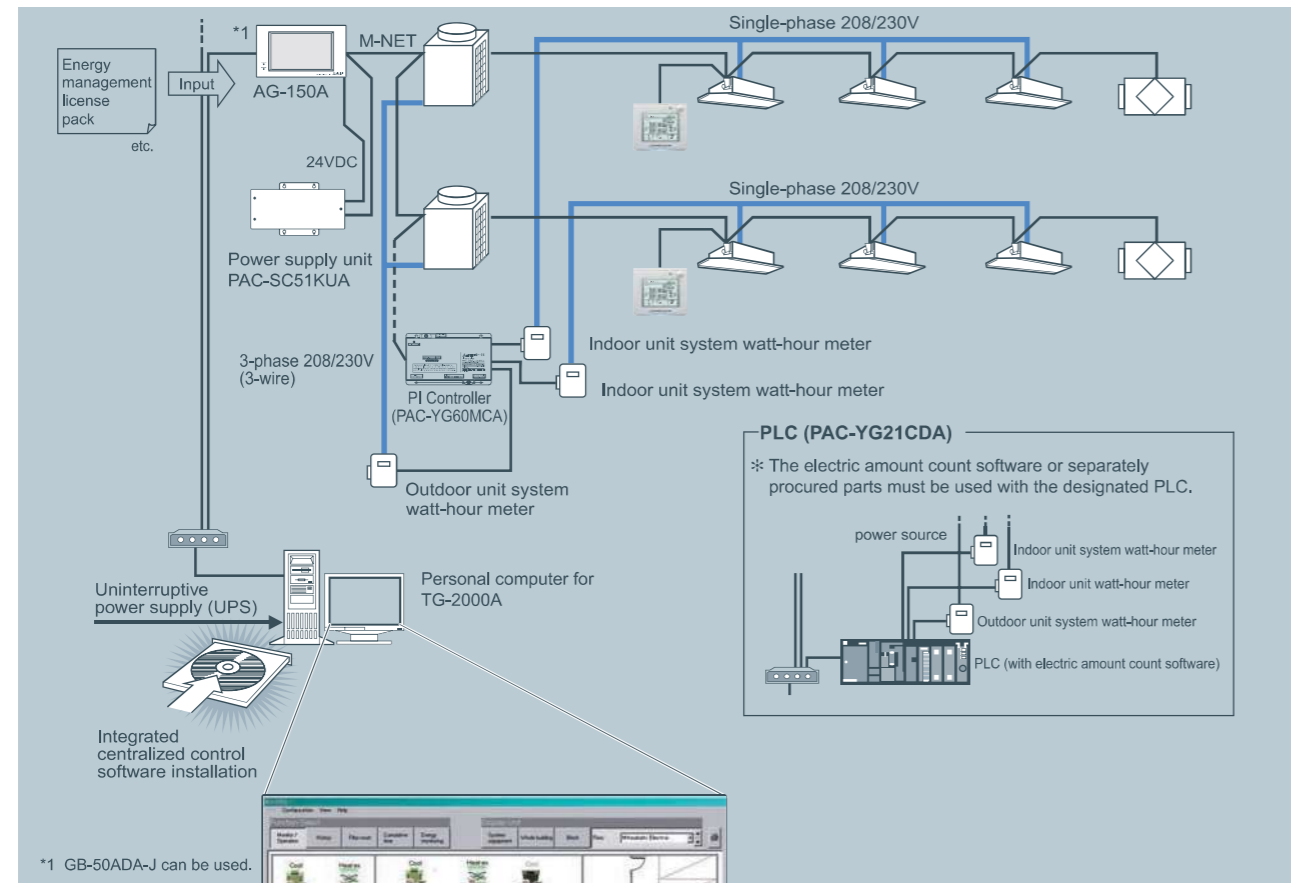

The air-conditioning layout can be displayed on the screen, making control and operation easier.

Effective use of TG-2000A

Multiple air conditioning in multiple buildings can be calculated. The power apportionment percentage data and apportioned power rate can be calculated for each unit, and can be output as a CSV file.



For example, installing TG-2000A to the system in the headquarters makes it possible to control AG-150A/GB-50ADA-J units that are used in branch offices.

LONWORKS® (LMAP04)

CITY MULTI can easily combine into a Building Management System (BMS) via the LONWORKS® and M-NET adapter LMAP04. LONWORKS® is an opened transmission protocol widely used at BMS, and related equipment control. CITY MULTI is therefore compatible with large-scaled BMS management via LONWORKS®.

One LM ADAPTER unit can connect up to 50 Groups/50 indoor units.

Using a single LONWORKS® adapter (LM-AP), you can connect up to a maximum of 50 indoor units.

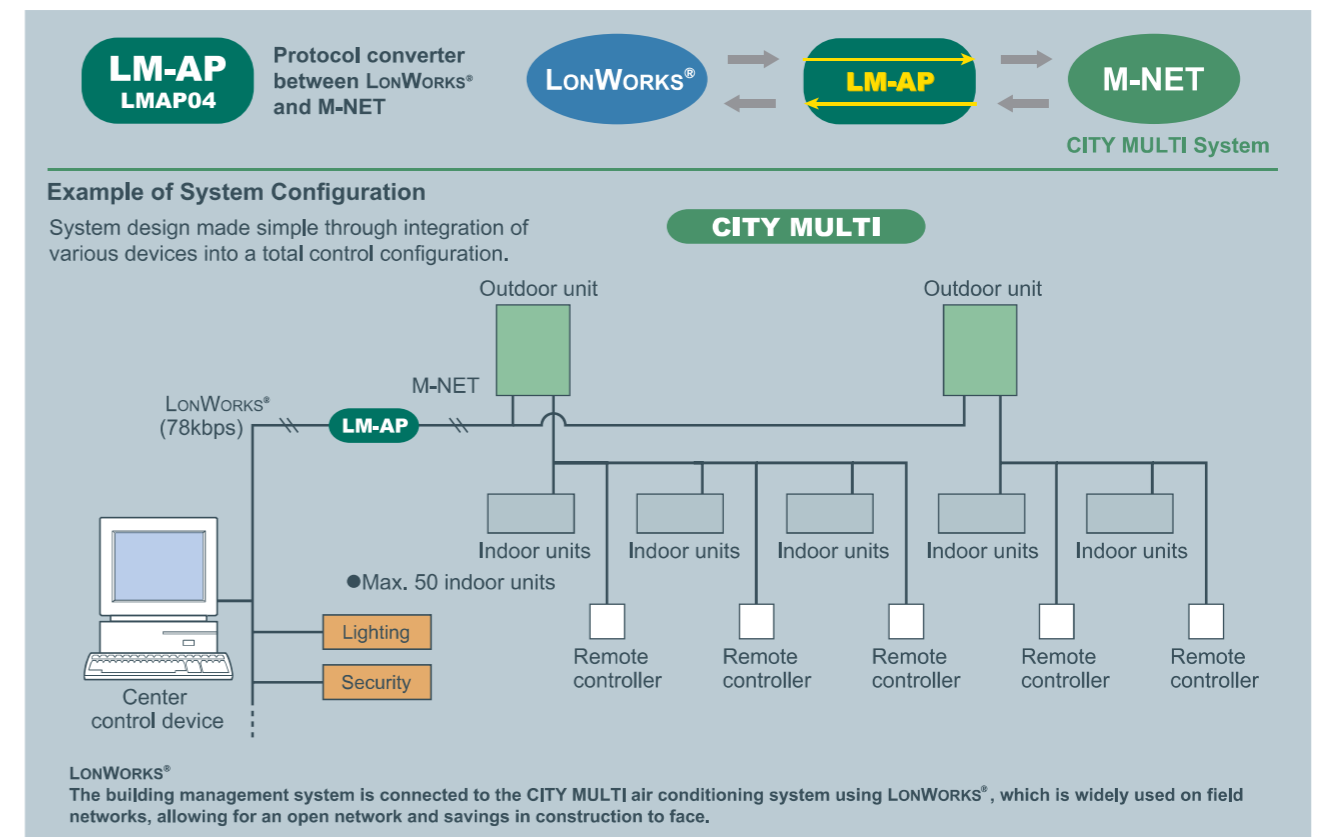

LON, LONWORKS® and the Echelon logo are trademarks of Echelon Corporation registered in the United States and other countries.

LONWORKS® INTERFACE

FUNCTION	CONTENT
Control	
ON/OFF	Run/Stop
Mode Operation	Cooling/Drying/Heating/Auto/Fan/Setback
Setpoint Adjustment	Cooling 19-35°C, Heating 4.5-28°C, Auto 19-28°C
Fan Speed Control	Lo-Mi1-Mi2-Hi
Permit/Prohibit	ON/OFF, Mode, Setpoint
Emergency Stop	-
Monitoring	
ON/OFF	Run/Stop
Mode	Cooling/Drying/Heating/Auto/Fan/Setback
Setpoint	Cooling 19-35°C, Heating 4.5-28°C, Auto 19-28°C
Fan Speed	Lo-Mi1-Mi2-Hi
Permit/Prohibit	ON/OFF, Mode, Setpoint
Alarm State	Normal/Abnormal
Room Temperature	-10°C~50°C
Thermo ON/OFF	ON/OFF

Centralized Remote Controller

BACnet® (BAC-HD150)

CITY MULTI can easily combine into a Building Management System (BMS) via the BACnet® and M-NET adapter BAC-HD150. BACnet® is an opened transmission protocol widely used at BMS, and related equipment control. CITY MULTI is therefore compatible with large-scaled BMS management via BACnet®.

BAC-HD150 can control up to 50 units/groups (including LOSSNAY).

Up to 150 units/groups (including LOSSNAY) can be controlled from one BAC-HD150 with three expansion controllers PAC-YG50ECA. (50 units/PAC-YG50ECA)

When the dual-set-point function is used, no expansion controllers can be connected, and only up to 50 units/groups can be controlled from each BAC-HD150.

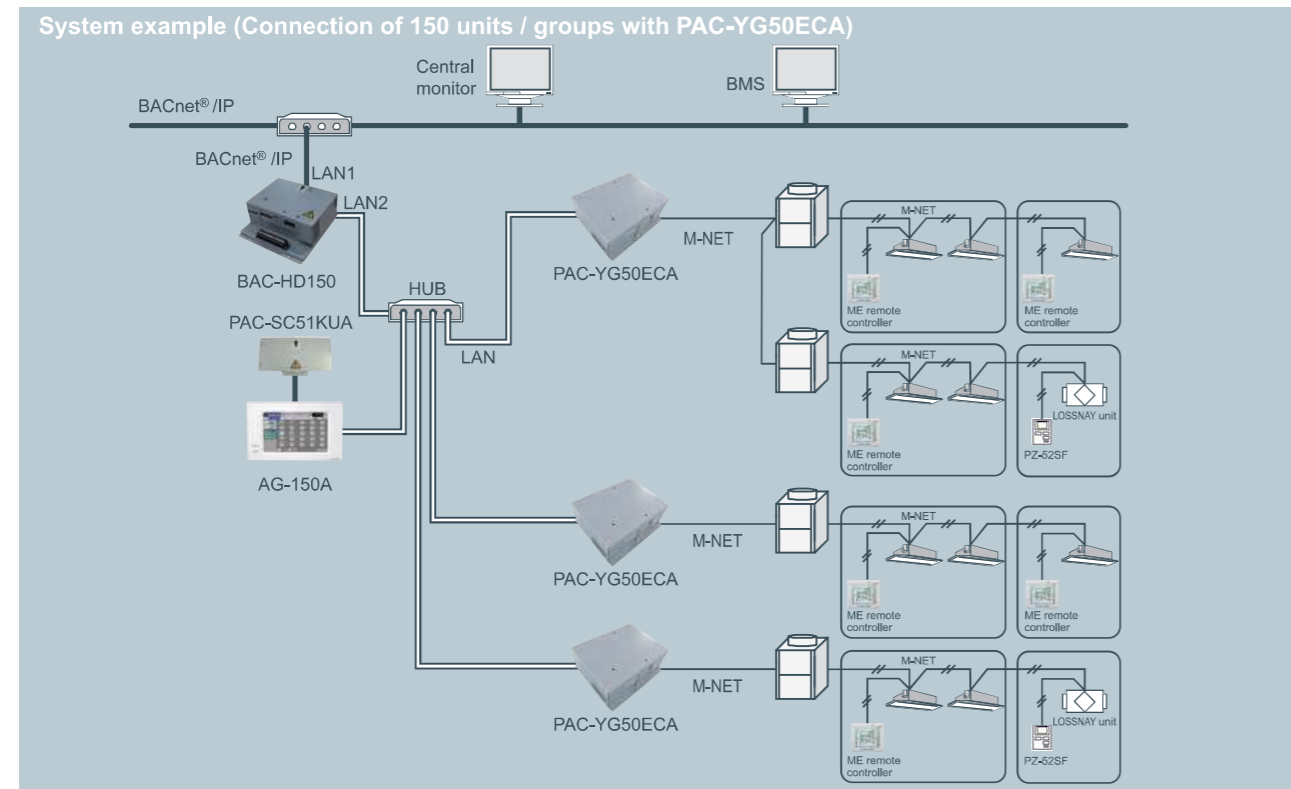

BACnet® and M-NET adapter

FUNCTION	CONTENT
Operation	
ON/OFF	Run/Stop
Mode	Cool/Dry/Heat/Auto/Fan/Setback
Fan Speed	Low-Mid1-Mid2-Hi
Airflow Direction	Horizontal- 60°-80°-100°swing
Set Temperature	Cooling 19-35°C [67-95°F], Heating 4.5-28°C [40-83°F], Auto 19-28°C [67-83°F]
Filter Sign Reset	Normal/Reset
Permit/Prohibit	ON/OFF, Mode, Filter sign reset, Set temp.
Forced OFF	Release/Effective
Monitoring	
ON/OFF	Run/Stop
Mode	Cool/Dry/Heat/Fan/Setback
Fan Speed	Low-Mid1-Mid2-Hi
Air Direction	Horizontal- 60°-80°-100°swing
Set Temperature	Cooling 19-35°C [67-95°F], Heating 4.5-28°C [40-83°F], Auto 19-28°C [67-83°F]
Filter Sign	Normal/Reset
Permit/Prohibit	ON/OFF, Mode, Filter sign reset, Set temp.
Indoor Temperature	-
Alarm Signal	Normal/Abnormal
Error Code	2 Character code- Indicates all unit alarms
Communication State	Normal/Abnormal

Remote Controller